

# DIN-411-10A DALI LED Dimming Driver (DIN Rail, screw dual-use)

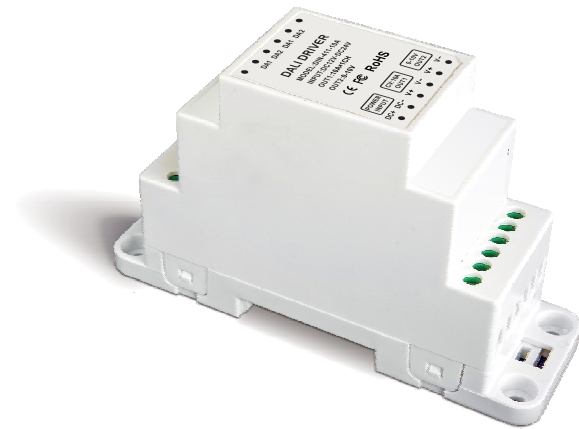

LTECH developed a new DALI to PWM dimming driver which has solved the compatible problem of the fluorescent dimming system and the LED illumination. LED lamps can be controlled by many traditional intelligent dimming systems such as Lutron, Dynalite, Tridonic, Schneider, Clipsal, Osram, Philips, ABB, etc.

DIN-411-10A CV dimming driver adopts the latest DALI standard IEC62386(compatible with the old standard IEC60929), It can load Max 10A current, 12V can load max 120W, 24V can load max 240W.

## 1. Product Parameter:

### DIN-411-10A DALI LED Dimming Driver

- Input Signal: DALI Dimming Signal(IEC62386/IEC60929)
- Input Voltage: DC12V~DC24V
- Output: 10A x1CH+0-10V x 1CH
- Max Output Power: 120W/240W(12V/24V)
- Dimming Range: 0-100%
- DIN Rail Mounting Size: TS-35/7.5 or TS-35/15
- Mounting: DIN Rail or Screw
- Working Temperature: -30°C-55°C
- Dimensions: L112×W35×H67mm
- Package Size: L114×W37×H70mm
- Weight(G.W.): 120g

## 2. Product Dimension:

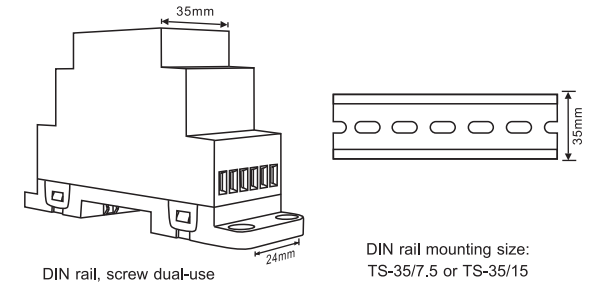
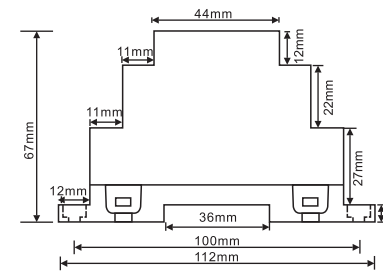

## 3. Conjunction Diagram:

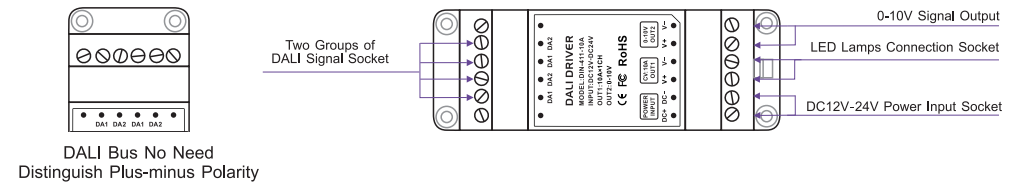

### 1) Connection Diagram for Single Unit :

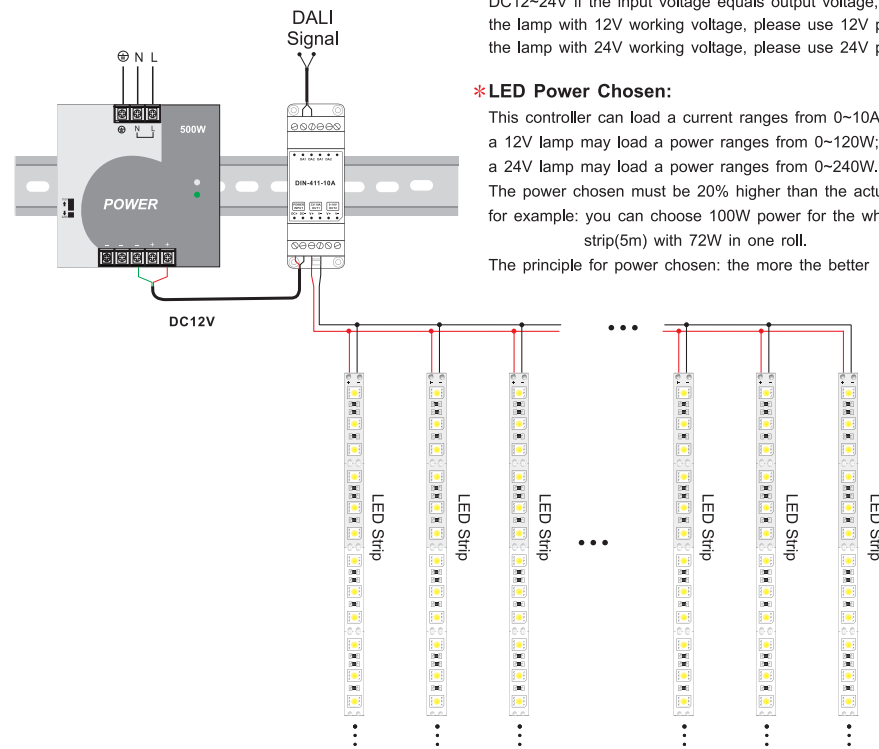

### \* LED Voltage Chosen:

This controller can wire to the LED lamps with a voltage ranges from DC12~24V if the input voltage equals output voltage, for example: the lamp with 12V working voltage, please use 12V power supply, the lamp with 24V working voltage, please use 24V power supply.

### \* LED Power Chosen:

This controller can load a current ranges from 0~10A, a 12V lamp may load a power ranges from 0~120W; a 24V lamp may load a power ranges from 0~240W. The power chosen must be 20% higher than the actual load, for example: you can choose 100W power for the white LED strip(5m) with 72W in one roll.

The principle for power chosen: the more the better

2) Connection Diagram for Multiple Units :

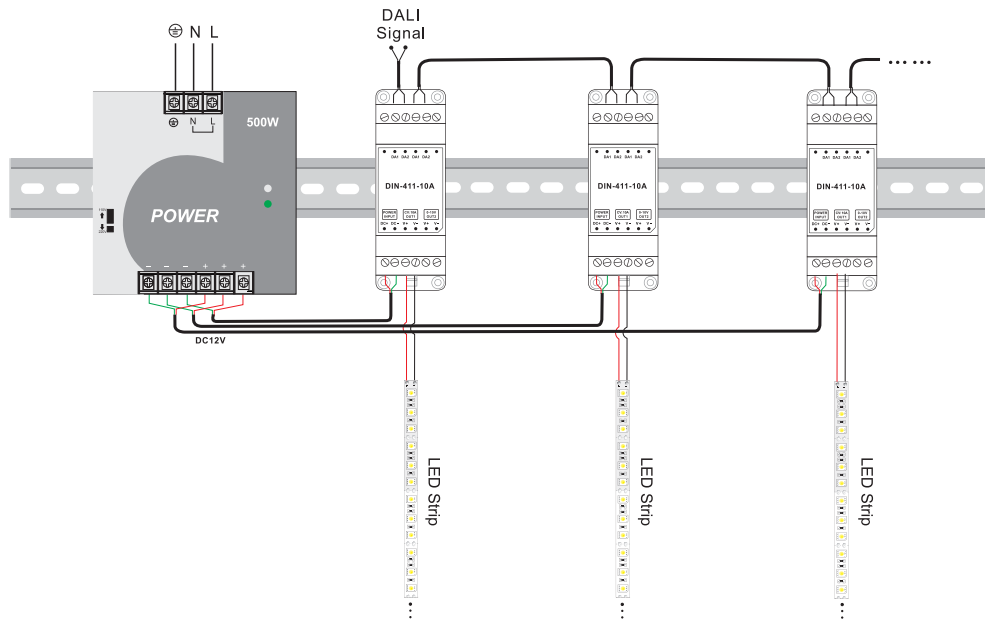

3) System Connection Diagram:

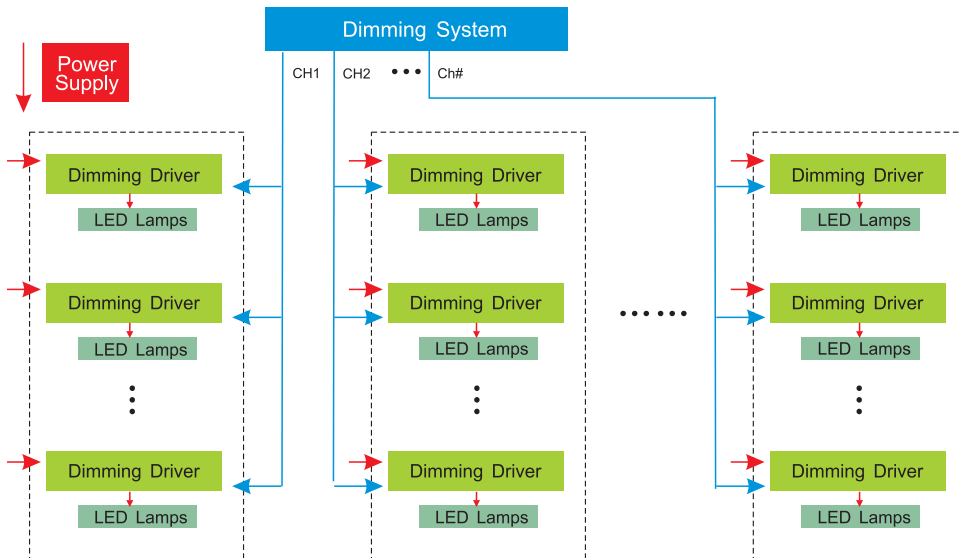

4. Attention:

- 1) The product shall be installed and serviced by a qualified person.
- 2) This product is non-waterproof. Please avoid the sun and rain. When installed outdoors please ensure it is mounted in a water proof enclosure.
- 3) Good heat dissipation will prolong the working life of the controller. Please ensure good ventilation.
- 4) Please check if the output voltage of any LED power supplies used comply with the working voltage of the product.
- 5) Please ensure that adequate sized cable is used from the controller to the LED lights to carry the current. Please also ensure that the cable is secured tightly in the connector.
- 6) Ensure all wire connections and polarities are correct before applying power to avoid any damages to the LED lights.
- 7) If a fault occurs please return the product to your supplier. Do not attempt to fix this product by yourself.

5. Warranty Agreement:

- 1) We provide lifelong technical assistance with this product:
  - A 5-year warranty is given from the date of purchase. The warranty is for free repair or replacement and covers manufacturing faults only.
  - For faults beyond the 5-year warranty we reserve the right to charge for time and parts.
- 2) Warranty exclusions below:
  - Any man-made damages caused from improper operation, or connecting to excess voltage and overloading.
  - The product appears to have excessive physical damage.
  - Damage due to natural disasters and force majeure.
  - Warranty label, fragile label and unique barcode label have been damaged.
  - The product has been replaced by a brand new product.
- 3) Repair or replacement as provided under this warranty is the exclusive remedy to the customer. LTECH shall not be liable for any incidental or consequential damages for breach of any stipulation in this warranty.
- 4) Any amendment or adjustment to this warranty must be approved in writing by LTECH only.

★ This manual only applies to this model. LTECH reserves the right to make changes without prior notice.